

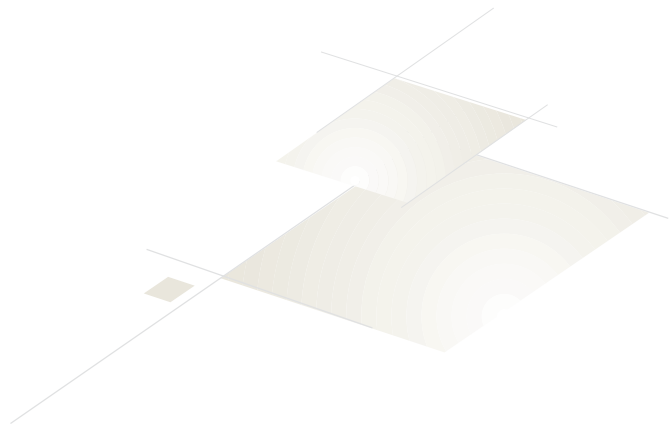

TIRADORES HANDLES





TIRADORES HANDLES



E-376

FIO 0361

Tirador en zamak cromado con embellecedor en ABS negro. Fijación horizontal o vertical por el exterior oculta. 2 M5

Chromed zamak handle with ABS black cover. Horizontal or vertical fixing outside concealed. 2 M5

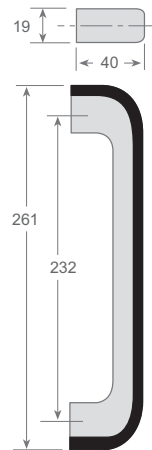
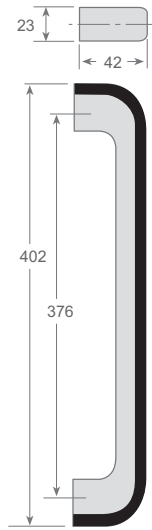

E-222

FIO 0362

Tirador en acero inoxidable AISI 304

AISI 304 stainless steel handle



VI-400-I

FIO 4460

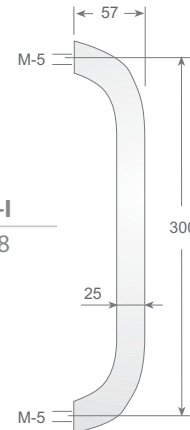
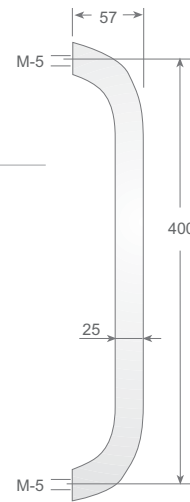

VI-300-I

FIO 4468

E-376 - E-222

Modelo Version	Código Code	Peso Weight
E-376	FIO 0361	169 grs.
E-222	FIO 0362	133 grs.

TIRADORES HANDLES

VI-400/300-I

Modelo Version	Código Code	Peso Weight
VI-400-I	FIO 4460	483 grs.
VI-300-I	FIO 4468	450 grs.



TIRADORES HANDLES

Tirador en ABS negro con embellecedor en aluminio anodizado plata.
Fijación horizontal o vertical por el exterior oculta. 2 M5

ABS black handle with silver anodized aluminium cover.
Horizontal or vertical fixing outside concealed. 2 M5

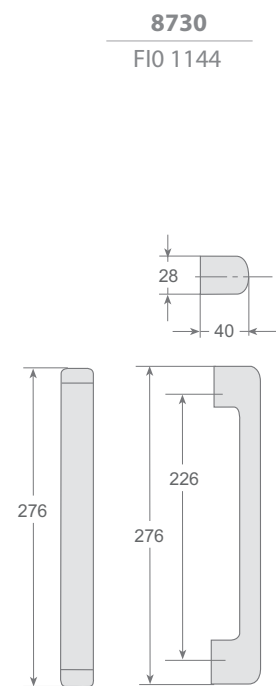
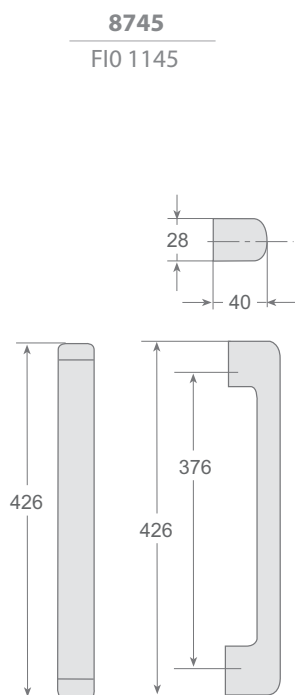

375

Modelo Version	Código Code	Peso Weight
G-375	FIO 0356	171 grs.

TIRADORES HANDLES

8745 - 8730

Modelo Version	Código Code	Peso Weight
8745	FIO 1145	159 grs.
8730	FIO 1144	112 grs.



TIRADORES HANDLES

380

FIO 0962

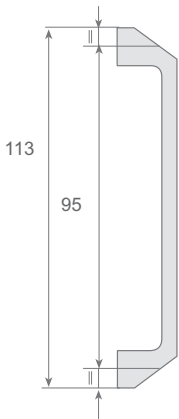
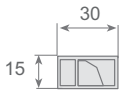

Tirador en zamak cromado con embellecedor en ABS negro.
Fijación horizontal o vertical por el exterior oculta. 2 M5

Chromed zamak handle with ABS black cover.
Horizontal or vertical fixing outside concealed. 2 M5

385

FIO 0392

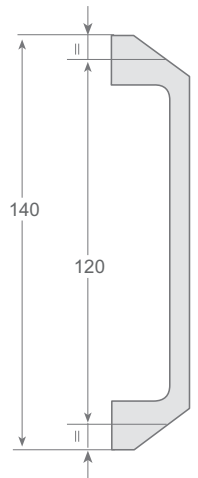
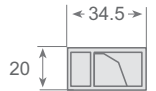

390

FIO 0964

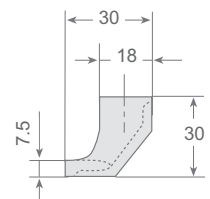
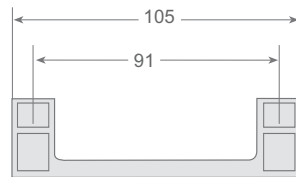

Modelo a extinguir / Model to extinguish

380 - 385

Modelo Version	Código Code	Peso Weight
380	FIO 0962	109 grs.
385	FIO 0392	68 grs.

**TIRADORES
HANDLES**

390

Modelo Version	Código Code	Peso Weight
390	FIO 0964	80 grs.



TIRADORES HANDLES

Tirador en ABS negro.

Fijación horizontal o vertical por el exterior. 2 M5.

ABS black handle. Horizontal or vertical fixing outside. 2 M5

MFL-84

F10 1387

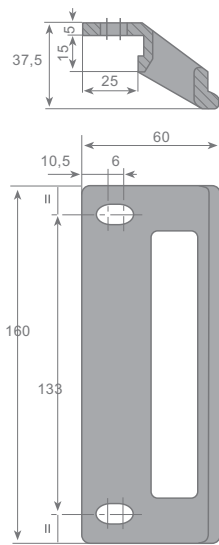

Tirador en zamak cromado. Fijación mediante espárragos roscados (M-4)
Aplicación horizontal o vertical

Chromed zamak handle. Fixing by threaded pegs (M-4)
Vertical or horizontal application.

VI-72

F10 0938

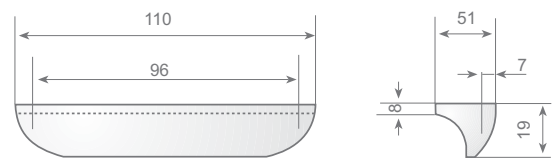

MFL-84

Modelo
Version

Código
Code

Peso
Weight

MFL-84

F10 1387

53 grs.

**TIRADORES
HANDLES**

VI-72

Modelo
Version

Código
Code

Peso
Weight

VI-72

F10 0938

57 grs.



TIRADORES HANDLES



209
FI0 0353

Tirador en zamak cromado con embellecedor en plástico color negro. Fijación mediante espárragos roscados (M-6)
Aplicación horizontal o vertical

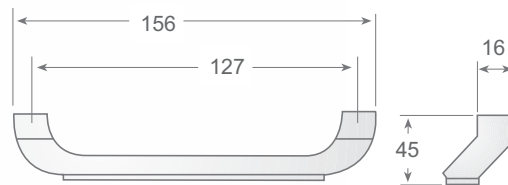

Chromed zamak handle with plastic cover in black colour.

*Fixing by threaded pegs (M-6)
Vertical or horizontal application.*



VI-62
FI0 0937

Tirador en zamak cromado. Fijación mediante espárragos roscados (M-4)
Aplicación horizontal o vertical

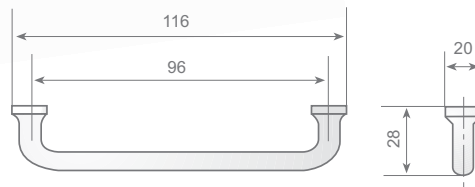

Chromed zamak handle.
Fixing by threaded pegs (M-4)
Vertical or horizontal application

209

Modelo Version	Código Code	Peso Weight
209	FI0 0353	213 grs.

**TIRADORES
HANDLES**

VI-62 / VI-72

Modelo Version	Código Code	Peso Weight
VI-62	FI0 0937	52 grs.



TIRADORES HANDLES

Tirador en AISI 316 pulido.
Fijación mediante espárragos roscados (M-4)
Aplicación horizontal o vertical

AISI 316 polished handle.
Fixing by threaded pegs (M-4)
Vertical or horizontal application.



VI-63-I

FIO 2714

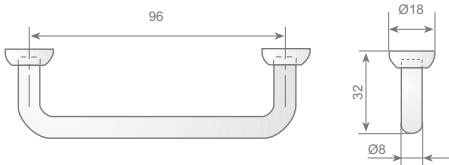

VI-64-I

FIO 2715

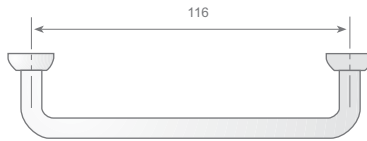

VI-65-I

FIO 2716

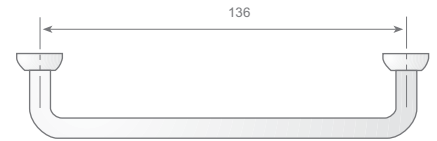

VI-67 I

FIO 8301



Tirador en AISI 316 satinado
Fijación mediante espárrago roscados (M-4)
Aplicación horizontal o vertical

*AISI 316 satin finish handle
Fixing by threaded pegs (M-4)
Vertical or horizontal application*

VI-66 I

FIO 8300

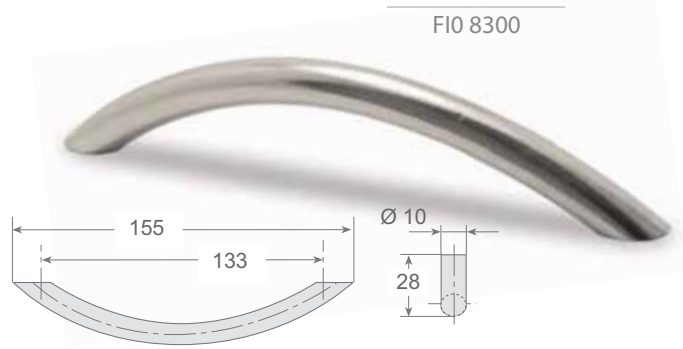

Tirador en AISI 316 satinado
Fijación mediante espárragos roscados (M-4)
Aplicación horizontal o vertical.

*AISI 316 satin finish handle.
Fixing by threaded pegs (M-4)
Vertical or horizontal application.*

VI-63-64-65

Modelo Version	Código Code	Peso Weight
VI-63 I	FIO 2714	59 grs.
VI-64 I	FIO 2715	68 grs.
VI-65 I	FIO 2716	74 grs.

TIRADORES HANDLES

Modelo Version	Código Code	Peso Weight
VI-67 I	FIO 8301	114 grs.
VI-66-I	FIO 8300	100 grs.



TIRADORES HANDLES



Tirador en AISI 316 pulido.
AISI 316 polished handle.

VI-120
FIO 1264

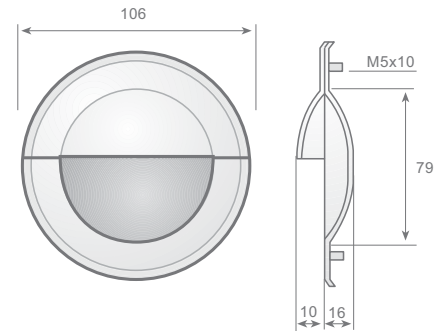

Tirador embutido en ABS negro / Fijación horizontal o vertical.
Black ABS stamped handle / Vertical or horizontal finish.

VI-68 P
FIO 8302



VI-34 P
FIO 3831



VI-120

Modelo Version	Código Code	Peso Weight
VI-120	FIO 1264	86 grs.

TIRADORES HANDLES

VI-68 / VI-34

Modelo Version	Código Code	Peso Weight
VI-68 P	FIO 8302	50 grs.
VI-34 P	FIO 3831	25 grs.



TIRADORES HANDLES

Tirador en plástico negro para empotrar
Aplicación horizontal o vertical.

*Recessed plastic handle. Black colour.
Vertical or horizontal application.*



Ref.	A ^(mm)	B ^(mm)	C ^(mm)
VI-92-P	92	83	36
VI-138-P	138	127	36
VI-189-P	189	177	44

VI-92-P		
Modelo Version	Código Code	Peso Weight
VI-92-P	F10 0306	17 grs.

TIRADORES HANDLES

VI-138-P / VI-189-P		
Modelo Version	Código Code	Peso Weight
VI-138-P	F10 0307	26 grs.
VI-189-P	F10 0308	50 grs.



TIRADORES HANDLES

Tirador en aluminio extrusionado anodizado
Plata brillante.
Largo standard: 3 mts.
Fijación por inyección.

Anodized and extruded aluminium handle.
Plated silver.
Standard length: 3 mts.
Fixing by means of injection.

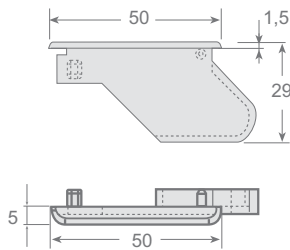
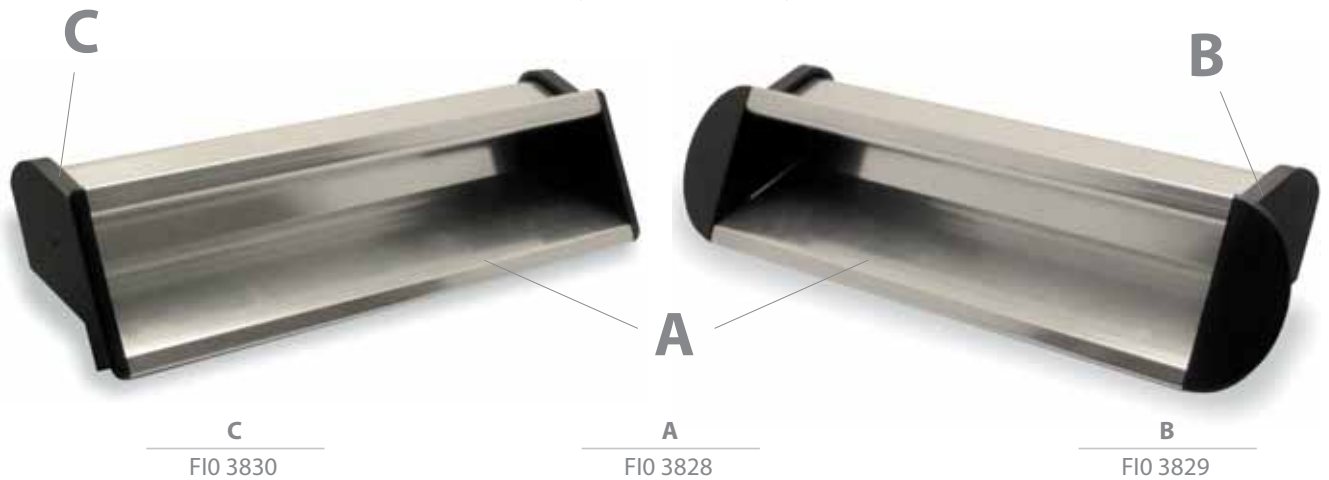

Tapa / Cover
Terminal plano
Planar end cap

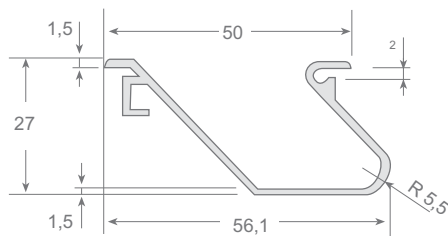

Tirador / Handle
Largo/length:
3 mts.

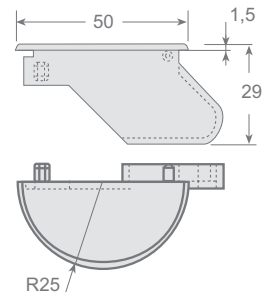

Tapa / Cover
Terminal redondo
Round end cap

Tirador / Handle

Modelo Version	Código Code	Peso Weight
A	FI0 3828	477 grs.

TIRADORES HANDLES

Tapas / Cover

Modelo Version	Código Code	Peso Weight
B	FI0 3829	4 grs.
C	FI0 3830	3 grs.



TIRADORES HANDLES

Tirador en aluminio extrusionado anodizado *Anodized and extruded aluminium handle.*



Tapa Izquierda Plástico
Cod. F10 9206
Left Cover plastic

Tirador metalico anodizado
Cod. F10 9199
Anodized handle

Tapa Derecha Plástico
Cod. F10 9205
Left Cover plastic

Tirador / Handle

Modelo Version	Código Code	Peso Weight
Tirador Handle	F10 9199	285 grs.

TIRADORES HANDLES

Tapas/Cover

Modelo Version	Código Code	Peso Weight
Tapa I / Cover L	F10 9206	5 grs.
Tapa D / Cover R	F10 9205	5 grs.

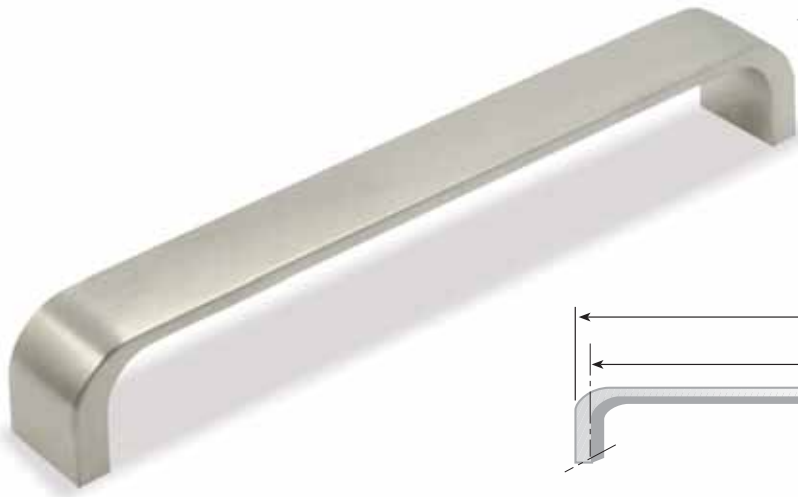

EST-1
FIO 2215

Tirador en zamak.
Acabado níquel cepillado.
Aplicación horizontal o vertical.

*Handle in Zamak.
Brush nickel finished.
Vertical or horizontal application.*

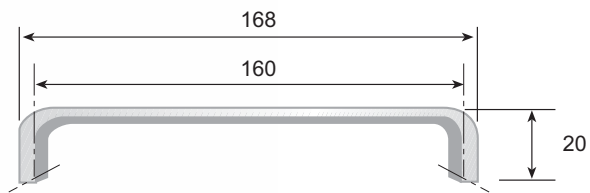

EST-2

FIO 2213

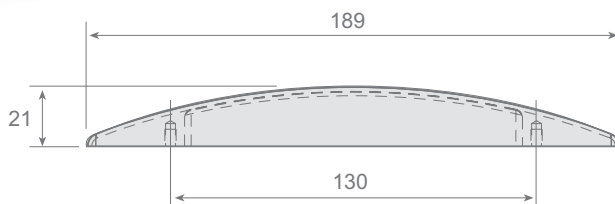

Tirador en zamak.
Acabado Cromado
Aplicación horizontal o vertical.

*Handle in Zamak.
Chromed finished.
Vertical or horizontal application.*

EST-3

FIO 2217

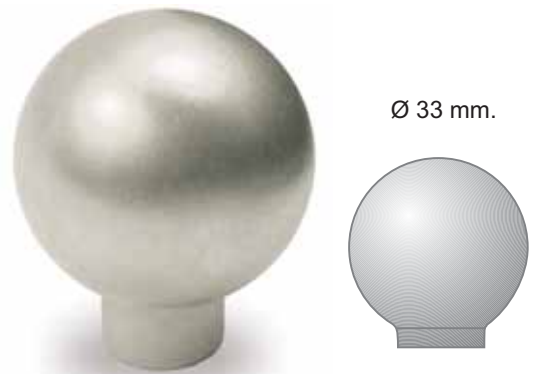

Ø 33 mm.

Pomo en Zamak acabado níquel cepillado
Zamak knob, brush nickel finished.

TIRADORES HANDLES

Modelo Version	Código Code	Peso Weight
EST-1	FIO 2215	130 grs.
EST-2	FIO 2213	140 grs.

Modelo Version	Código Code	Peso Weight
EST-3	FIO 2217	120 grs.



TIRADORES HANDLES

Tirador en Aluminio cromado. Aplicación horizontal o vertical.
 Chrome aluminium finished. Vertical or horizontal application.

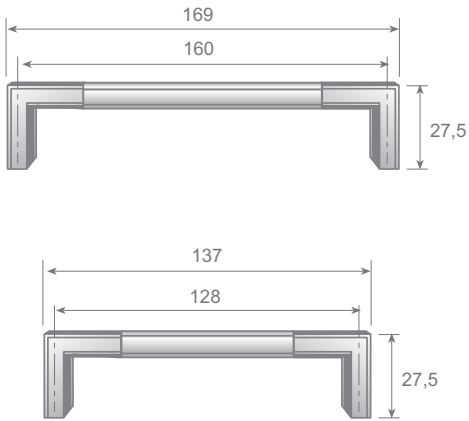

Modelo a extinguir / Model to extinguish

Tirador acabado en cromado plata.
 Aplicación horizontal o vertical.

Handle in chrome silver printed finished.
 Vertical or horizontal application.

EST-6
 FIO 9184

EST-7
 FIO 9182

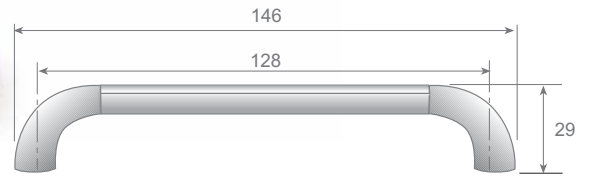
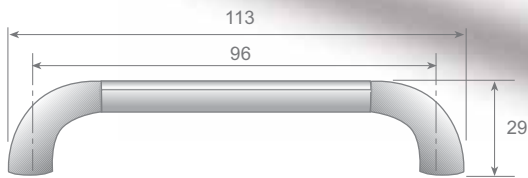

Modelo Version	Código Code	Peso Weight
EST-4	FIO 9187	90 grs.
EST-5	FIO 9188	95 grs.

TIRADORES HANDLES

Modelo Version	Código Code	Peso Weight
EST-6	FIO 9184	75 grs.
EST-7	FIO 9182	79 grs.



TIRADORES HANDLES

Tirador acabado en cromado plata.
Aplicación horizontal o vertical.

Handle in chrome silver printed finished.
Vertical or horizontal application.

EST-9
FI0 9180



EST-10
FI0 9181

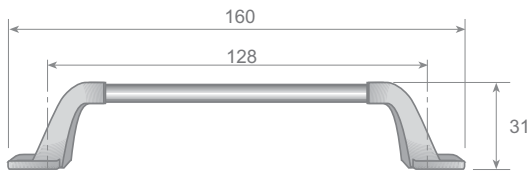

Modelo a extinguir / Model to extinguish

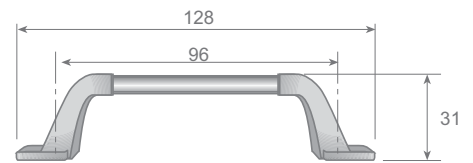

Modelo a extinguir / Model to extinguish

EST-9

Modelo Version	Código Code	Peso Weight
EST-9	FI0 9180	93 grs.

TIRADORES HANDLES

EST-10

Modelo Version	Código Code	Peso Weight
EST-10	FI0 9181	83 grs.



TIRADORES HANDLES

Tirador acabado en cromo satinado
Fijación horizontal o vertical

*Handle in satin chrome finished
Vertical or horizontal finish*

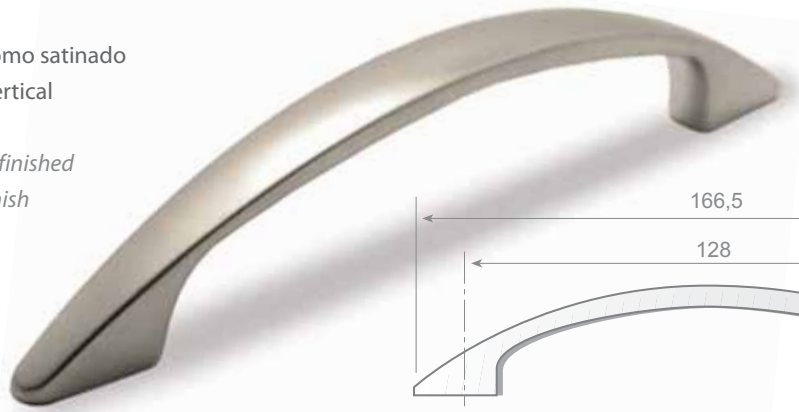

EST-11
FI0 9186

EST-12
FI0 9189

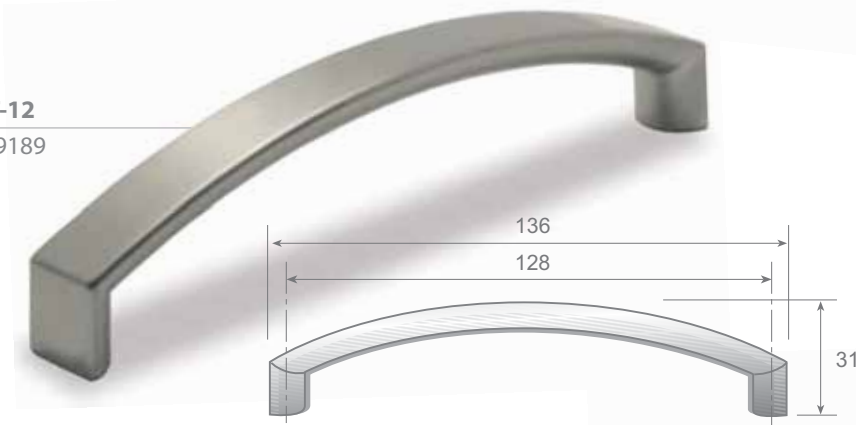

Tirador acabado en níquel cepillado
Aplicación horizontal o vertical

*Handle in brush nickel finished
Vertical or horizontal application*

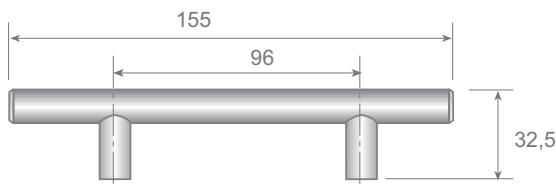

EST-13
FI0 9190

EST-11 / EST-12

Modelo Version	Código Code	Peso Weight
EST-11	FI0 9186	69 grs.
EST-12	FI0 9189	91 grs.

TIRADORES HANDLES

EST-13

Modelo Version	Código Code	Peso Weight
EST-13	FI0 9190	161 grs.